



# XRS™ Connect

COMPACT HIDEAWAY 80 CHANNEL UHF CB RADIO



**INSTRUCTION MANUAL**

## CONTENTS

<b>CONTENTS</b> .....	<b>2</b>
<b>INTRODUCTION</b> .....	<b>6</b>
<b>FEATURES</b> .....	<b>6</b>
<b>XRS CONNECT APP</b> .....	<b>8</b>
XRS Connect .....	8
Pairing.....	9
<b>GENERAL OPERATION</b> .....	<b>10</b>
Front Panel .....	10
Rear Panel.....	10
Controller Microphone.....	11
<b>GENERAL</b> .....	<b>11</b>
Power.....	11
Auto Power-Down .....	11
Volume.....	12
Selecting Channels .....	12
Squelch .....	12
Adjusting the Squelch Level.....	13
Signal Meter .....	13
Brightness.....	13
Transmitting .....	14
Time-out Timer .....	14
Busy Lockout .....	14
Voice Scrambler .....	15
Beep Tone Volume.....	15
Dynamic Volume Control (DVC) .....	16
Selecting the Active Speaker.....	16

Microphone Gain.....	17
Squelch Tail.....	17
Roger Beep .....	18
Repeater and Duplex Mode.....	18
Priority Channel .....	19
<b>SCANNING .....</b>	<b>20</b>
Scan Groups.....	20
Programming the Scan Memories.....	21
Auto Skip .....	21
Dual Watch .....	22
Open Scan.....	23
Selecting Open Scan.....	23
Priority Scan .....	24
Selecting Priority Scan.....	25
<b>NETWORK SCAN (NET-SCAN) .....</b>	<b>26</b>
Enabling Net-Scan .....	26
Using Net-Scan .....	27
Ending the Scan.....	27
<b>CTCSS AND DCS .....</b>	<b>28</b>
Choosing CTCSS or DCS .....	28
CTCSS Tone Set Compatibility .....	28
Enabling CTCSS/DCS on a Channel (Silent Mode).....	29
Busy Lockout .....	30
Monitor Function .....	30
<b>SELECTIVE CALLING .....</b>	<b>31</b>
SelCall Identification Number .....	31
SelCall Naming .....	31

The Quiet Mode .....	32
Sending a SelCall .....	32
Receiving a SelCall .....	32
Quiet Mode .....	33
<b>GROUP CALLING .....</b>	<b>35</b>
Programming and Sending Group Calls.....	35
Call acknowledge in Group Mode .....	36
Storing Group Call Idents.....	36
Receiving Group Calls .....	36
<b>MENU OPTIONS .....</b>	<b>37</b>
Context Menu Examples .....	37
<b>MENU TABLE .....</b>	<b>39</b>
Receive-only Channels (Zones).....	41
Select a Zone .....	42
Edit a Zone Name .....	42
Add Channels to a Zone .....	44
Edit Existing Channels in a Zone .....	45
Bluetooth .....	47
Programmable Buttons .....	48
Functions .....	50
Radio Settings .....	51
Scan Settings.....	53
Net-Scan .....	54
SelCall .....	54
Making a SelCall .....	55
Resending the Last SelCall Number .....	56
Editing the Contact Name .....	56

Editing your Radio's Own SelCall Number.....	57
Adding a New Contact to the SelCall Memory .....	58
<b>XRS FEATURES .....</b>	<b>59</b>
Location Services.....	59
GPS Data Acquisition.....	59
Location Services.....	61
Voice Playback.....	64
Active Mute .....	65
<b>INSTALLATION .....</b>	<b>66</b>
General.....	66
Mounting the Cradle.....	67
Fitting the Controller Microphone .....	68
DC Power Connection .....	68
Radio Remains ON when the Ignition Switch is OFF .....	68
Radio Turns ON and OFF with the Ignition Switch .....	69
High Voltage Detection .....	69
Mounting the Radio.....	70
Antenna Connection.....	71
Noise Suppression .....	71
Wiring .....	72
Frequency and Subtone Tables .....	73
<b>SPECIFICATIONS.....</b>	<b>76</b>
Electrical .....	76
Mechanical Specifications and Connections .....	78
Notes .....	79

## INTRODUCTION

Your GME XRS Connect 80 channel radio is Australian designed and manufactured and is the most advanced UHF Citizen Band radio available. It combines the very latest in electronic hardware with the most up-to-date computer aided design and manufacturing techniques to produce a compact mobile radio with outstanding specifications, features and performance.

The XRS Connect speaker microphone with OLED display and front mounted speaker provides clear sound and total control from the palm of your hand allowing your radio to be mounted almost anywhere in your vehicle.

XRS Connect are the first UHF CB radios with an app to configure and control the radio. Visit [gme.net.au/GETXRS](http://gme.net.au/GETXRS) for more information.

## FEATURES

This section lists the various features available on your XRS Connect radio.

- **Transmit (TX)**
  - **Individually Programmable Duplex Function:** User selectable for only those individual channels in your area that have repeaters, leaving the others free for use as extra simplex channels.
- **Receive (RX)**
  - **Squelch Tail:** Can be switched off to eliminate the audible noise burst normally heard when the Squelch closes.
  - **User Programmable Receive Channels:** 8 zones of 50 channels per zone for a total of 400 additional receive-only channels.
  - **Digital Signal-Strength Meter:** Provides a numeric signal strength indication in numbers from 0 to 9+.
- **Scanning and memory functions**
  - **Microprocessor Controlled Frequency Synthesiser:** Allows user programmable control of scanning, channel memories and selected feature options.
  - **Programmable Scan Function:** Scans the selected UHF CB channels with Open, Priority and Network scan functions available.

- **Priority Channel:** A user programmable Priority channel for instant recall at the press of a key.
- **Signal processing**
  - **Digital Signal Processing (DSP):** Measures, filters and compresses standard analogue audio signals and converts them into digital format. Allows advanced RF and audio processing techniques to be applied to maximise the radio's performance.
  - **Advanced Signal Management (ASM):** Identifies interference caused by strong local signals on adjacent channels and prevents these from opening your Squelch. ASM also minimises distortion on reception by fine tuning the receiver frequency to match that of the incoming signal.
  - **Dynamic Volume Control (DVC):** Automatically compensates for variations in received audio level to provide a constant audio output level to the speaker.
- **Privacy functions**
  - **Voice Inversion Scrambler:** When activated, scrambles your voice so that communications are only intelligible to others using the same scrambler technology.
  - **In-built CTCSS and DCS:** User selectable Continuous Tone Coded Squelch System and Digital Coded Squelch system provides silent operation on individual channels.
  - **In-Built SelCall with Quiet Mode:** Provides selective calling of individuals or groups with fully user-adjustable 5-tone transmitted SelCall Ident. Also allows alphanumeric naming of up to 20 Idents for easier caller identification.
- **Physical properties**
  - **Over Voltage Protection:** Special over voltage detection circuitry protects the radio and warns of excessive voltage conditions on the display.
  - **Rugged Construction:** With die-cast chassis.
- **User controls and interface**
  - **Full Function Controller Microphone:** Includes front mounted speaker to channel clear audio towards the user.

- **OLED Display:** Bright, high contrast, dot matrix OLED display is readable under all lighting conditions.

For a more detailed description of all key functions, refer the 'General Operation' section.

## XRS CONNECT APP

This section provides details about the **XRS Connect** app.



### To download the app for iOS or Android:

1. Visit App Store or Google Play.
2. Search for **XRS Connect**.

## XRS CONNECT

---

The **XRS Connect** app is the easy way to customise, update and maintain your XRS Connect radio using Bluetooth.

- When your device is paired to the radio, select the  **Read from Radio** button to read your radio's settings into the app.
- After you have configured your preferences in the app, select  **Write to Radio** to update your radio with your new settings.

For information on pairing your smart device with your XRS Connect radio, see the 'Pairing' section that follows.

**XRS Location Services** is a feature included in the XRS Connect app, available for iOS and Android devices. The XRS Connect app is connected to the XRS Connect radio via Bluetooth. The app allows users to share their location using the mobile device's GPS location. The location is broadcast by the radio at the end of a normal voice transmission. The location cannot be shared by the app without being connected to an XRS Connect radio.

XRS Location Services transmits your geographic location as a supplementary service to voice communication on CB channels. This feature complies with the Radio Communications (Citizen Band Radio Stations) Class Licence 2015.



GME values your privacy, and does not collect any of your location data. The location data is only stored within the XRS Connect app and is transmitted by your XRS Connect radio.

## PAIRING



---

### To pair your smart device with your XRS Connect radio:

1. Open the **Radios** section of the XRS Connect app.
2. A list of available radios will be displayed.  
The XRS Connect app is continually refreshing to search for new radios.
3. Locate your radio in the list and tap the name of the radio to pair.

If secure pairing is turned on;

In the radio's Bluetooth menu, navigate to **Pair** and select it to put the radio into 'pair' mode. You will be asked to confirm a security PIN on both the mobile device and radio. See the 'Bluetooth' section of this manual for information on secure pairing.

When successfully connected the  icon on your radio should change to  to show that the Bluetooth pairing is successful.

**Note:** The Bluetooth connection between your smart device and your XRS Connect radio must be made through the XRS Connect app. You will not be able to pair your smart device to your XRS Connect radio using the normal Bluetooth settings option on your smart device.

The XRS Connect app is compatible with iOS 14 and above and Android 8.0 and above.

# GENERAL OPERATION

## FRONT PANEL



Microphone Socket

## REAR PANEL

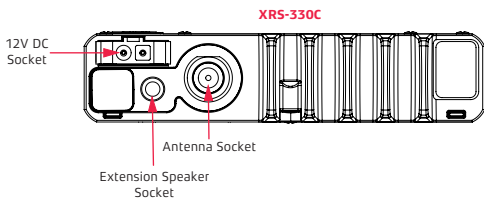

12V DC Socket

Antenna Socket

Extension Speaker Socket

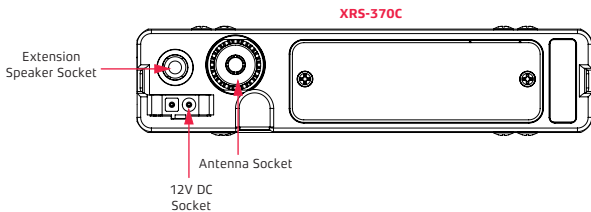

Extension Speaker Socket

Antenna Socket

12V DC Socket

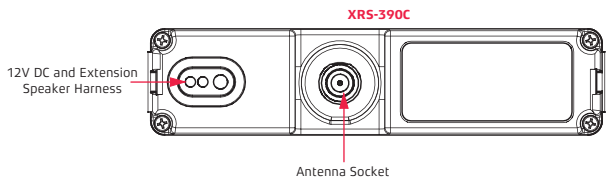

12V DC and Extension Speaker Harness

Antenna Socket

## CONTROLLER MICROPHONE

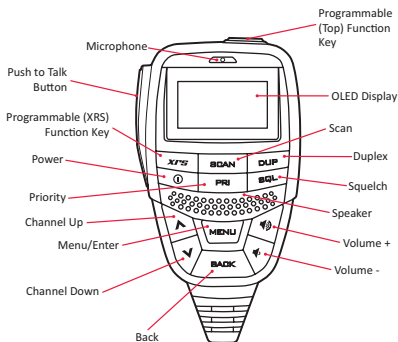

## GENERAL

### POWER

Press and hold the **(I)** key to turn the radio on. Press and hold the **(I)** key to turn the radio off.

### AUTO POWER-DOWN

The Auto Power-Down feature provides the ability for the radio to turn itself off after a user selectable time (based on your preference). By default, this feature is turned off.

#### To setup Auto Power-Down:

1. Press **MENU** and select **RADIO SETTINGS**.
2. Next, select **AUTO POWER**.
3. Select **TIMEOUT**, then press **MENU** to select an appropriate setting. The **NONE** option will disable this feature, while a setting of 30-180 minutes allows the radio to turn off after the selected time.

By default, while the Auto Power-Down feature is enabled, the radio will turn off after the preselected time even if the radio is receiving transmissions. If you would like to keep the radio on while it is receiving transmissions, this setting needs to be turned on. You can turn on this feature as follows:





1. Press **MENU** and select **RADIO SETTINGS**. Next select **AUTO POWER**.
2. Select **RECV RESETS** and press **MENU**. Select **ON** to turn the feature on.

By default, the radio will not automatically power down while it is connected to a device via Bluetooth. If you would like to power down the radio while you have a Bluetooth connection, turn this setting off.

1. Press **MENU** and select **RADIO SETTINGS**. Next, select **AUTO POWER**.
2. Select **B'THOOTH HALTS** and press **MENU** to select **OFF** to turn the feature off.

## VOLUME





---

- Press the  or  keys to adjust the volume.
- Press  to increase the volume or  to decrease the volume. The volume level is displayed on the OLED Display in values from 01 (min) to 31 (max).
- If no sound is heard, briefly press the **SQL** key to temporarily unmute the radio then adjust the volume while listening to the background noise. When finished, briefly press the **SQL** key again to re-mute the radio.

**Note:** At the minimum volume setting there is still sufficient volume to be heard in a quiet cabin environment.

## SELECTING CHANNELS

---

- To select a channel, press the  or  key.
- Press  to select a higher channel or  to select a lower channel. The selected channel is displayed on the OLED Display.
- Press and hold either key to advance quickly through the channels.

## SQUELCH

---

The Squelch is used to eliminate any annoying background noise when there are no signals present. The Squelch can be opened or closed using the **SQL** key.

When the Squelch is open the receiver's background noise can be heard and the  icon is displayed. When the Squelch is closed the receiver remains quiet while there are no signals present but any incoming signals will override the Squelch and be heard in the speaker.

## ADJUSTING THE SQUELCH LEVEL

---

The Squelch sensitivity level has been factory set to provide optimum performance under most operating conditions. If required, the sensitivity level can be adjusted to suit changing conditions.

### To adjust squelch sensitivity:

1. Press the **MENU** key.
2. Navigate to **RADIO SETTINGS > SQUELCH LEVEL**.  
You can use the  or  key to adjust the squelch level.

The default squelch sensitivity level is 3.

## SIGNAL METER

---

The signal meter indicates the relative strength of the incoming signal in numerical format. Signal strengths are displayed on the right of the Channel Display in values from 0 to 9. Signals above strength 9 are displayed as 9+.

## BRIGHTNESS

---

The OLED display and keys are backlit for easier viewing under a wide range of lighting conditions. The backlight remains on whenever the radio is switched on. The brightness level can be smoothly adjusted in steps from 0 to 10.

### To adjust brightness level:

1. Press the **MENU** key.
2. Navigate to **RADIO SETTINGS > BRIGHTNESS**.  
You can use the  or  key to adjust the brightness.

A Dim function can also be assigned to the programmable **XRS** key to quickly switch the brightness level to minimum for low light viewing. This saves having to manually readjust the brightness level when moving into low light environments.



To assign the Dim function to a key, press the **MENU** key and navigate to **PROG BUTTONS** and its options to configure this feature.

## TRANSMITTING

---

Prior to transmitting, always check the channel is clear. This can be done by listening to the channel or by visually checking that the  icon is not visible or the signal meter is not indicating a signal.

### To transmit:

1. Press the **PTT** on the microphone. The  icon will appear.
2. Hold the microphone about 3-5 cm from your face and speak at a normal voice level. Since the microphone is quite sensitive, it is not necessary to raise your voice or shout.
3. Release the **PTT** when you have finished talking, the  icon will disappear.

Always listen to ensure the channel is free before transmitting.

## TIME-OUT TIMER



---

The radio has a built-in time-out timer that automatically limits transmissions to a maximum of 3 minutes of continuous operation. This feature is required by the ACMA to prevent accidental blocking of the frequency should your PTT become jammed or be otherwise pressed accidentally.

When the time-out timer activates, the radio will give a low tone for a few seconds and the transmitter will be temporarily disabled. Release the **PTT** to restore normal operation.

## BUSY LOCKOUT

---

When enabled, the **Busy Lockout** function detects when someone is transmitting on the channel and prevents your radio from transmitting over them. If you press the **PTT** when the channel is busy the radio will emit a warning beep and the  icon won't be displayed. If this happens, look for the  icon on the display as an indicator that the channel is already in use. If the channel is busy, simply wait until the channel is clear and press the **PTT** again.

When **Busy Lockout** is disabled, you should check that the channel is clear before pressing the PTT to avoid transmitting over others who may be already transmitting on the channel.

#### To enable/disable busy lockout:

1. Press the **MENU** key.
2. Navigate to select **RADIO SETTINGS > BUSY LOCK**.  
You can use the **▲** or **▼** key to turn this function on or off.

## VOICE SCRAMBLER

---

Your radio incorporates a simple voice scrambler using band inversion. The scrambler is compatible with the majority of scramblers used by other manufacturers, allowing you to enjoy scrambled communications with owners of non-GME radios. Once the scrambler has been activated your transmission and reception will only be intelligible to others using the same scrambler technology.

#### To enable/disable voice scrambler:

1. Press the **MENU** key.
2. Navigate through the menu to select **RADIO SETTINGS > SCRAMBLER**.  
You can use the **MENU** key to turn this function on or off.

To avoid interference with other services or users, the scrambler cannot be enabled on channels 5, 11, 22, 23, 31-38, 61, 62, 63, 71-78 or on any channel that has been set to Duplex mode (1-8).

## BEEP TONE VOLUME

---

The Beep tone provides audible feedback whenever the keys are pressed. The Beep tone volume can be adjusted in values from 0 – 10.

To switch the beep off, select 0.

#### To adjust volume of beep tone:

1. Press the **MENU** key.
2. Navigate through the menu to select **RADIO SETTINGS > BEEP VOLUME**.  
You can use the **▲** or **▼** key to increase or decrease the beep tone.

## DYNAMIC VOLUME CONTROL (DVC)

---

The modulation level of signals heard on the UHF CB band has always varied considerably resulting in noticeable differences in received audio volume between stations.

Generally, users have compensated for this by adjusting the Volume control for each incoming signal.

With the introduction of 80 channel narrow band transmissions that use lower levels of modulation, the differences in received audio volume is likely to increase further.

Your XRS Connect radio is able to automatically compensate for these variations by utilising a Dynamic Volume Control. When activated through the menu, this feature automatically compensates for variations in received audio level resulting in a constant audio output level to the speaker.

### To activate/deactivate Dynamic Volume Control:

1. Press the **MENU** key.
2. Navigate through the menu to select **RADIO SETTINGS > DYNAMIC VOL.**

You can use the **MENU** key to turn this function on or off.

## SELECTING THE ACTIVE SPEAKER

---

The XRS-330C and XRS-390C both have a speaker mounted inside the microphone and support for connecting an external speaker.

The XRS-370C radio has two speakers - one mounted inside the radio and the other mounted inside the microphone.

By default, sound is reproduced by both speakers; however if you prefer, one of these speakers can be switched off, leaving either the microphone's speaker or the external/radio speakers to reproduce sound.

### To select speakers:

1. Press the **MENU** key.
2. Navigate through the menu to select **RADIO SETTINGS > SPEAKER.**  
You can use the **▲** or **▼** key to select an option.



## MICROPHONE GAIN

---

The microphone gain controls the sensitivity of the microphone to your voice input level. If you are quietly spoken or are operating in a quiet environment you can increase the microphone gain to make your voice sound clearer. If your voice is quite loud or you are working in a noisy environment and wish to minimise the amount of background noise that is picked up, you should reduce the microphone gain.

### To adjust microphone gain:

1. Press the **MENU** key.
2. Navigate through the menu to select **RADIO SETTINGS > MIC GAIN**. You can use the **▲** or **▼** key to increase or decrease the microphone gain.

NOTE: The Microphone Gain provides a 'fine' adjustment to the microphone sensitivity. A wider adjustment range is available through the XRS Connect App.

## SQUELCH TAIL

---

The Squelch Tail is the short burst of noise that is heard in the speaker at the end of a transmission just before the Squelch closes. To some it is a reassuring confirmation that it is their turn to transmit but in some applications it may be an annoyance especially when listening through an ear piece or headphones.

The Squelch Tail can be turned off, reducing it to a faint click as the Squelch closes.

### To enable/disable squelch tail:

1. Press the **MENU** key.
2. Navigate through the menu to select **RADIO SETTINGS > SQUELCH TAIL**. You can use the **MENU** key to turn this function on or off.

## ROGER BEEP

---

The Roger Beep is a tone that is automatically transmitted whenever the PTT is released. This tone serves to alert the receiving party that your transmission has ended.

1. Press **MENU** and select **RADIO SETTINGS**.
2. Select **ROGER BEEP** and press **MENU** to select **ON** or **OFF**.

When the Roger Beep tone is enabled, the ROG icon is displayed.

## REPEATER AND DUPLEX MODE

---

Duplex operation allows the radio to transmit on a different frequency to that which it receives. This allows operation through repeater stations.

A repeater station consists of a linked transmitter/receiver combination installed in a prominent location. The repeater is designed to receive signals on a designated channel and retransmit them on another channel. Repeaters are usually mounted on hills or tall buildings. The increased elevation greatly improves both the receiving and transmitting range of the repeater allowing it to receive and retransmit signals to radios that would otherwise be out of range of each other.

Normally, UHF CB radios transmit and receive on the same frequency - known as Simplex operation. However, to communicate through repeaters, your radio must be able to transmit and receive on different channels - otherwise known as Duplex operation. Your radio is fitted with a Duplex key to allow you to operate through repeaters.



The Duplex function can only be selected on channels 1 - 8 and 41 - 48 as these are the channels that have been allocated for repeater use. When Duplex is selected, your radio receives on the selected channel (e.g. CH 1) but transmits 30 channels higher (CH 31). The repeater hears your signal on CH 31 and retransmits it on CH 1 for others to hear.

Your XRS Connect radio allows you to enable or disable Duplex mode on individual repeater channels. In this way any repeater channels that are not being used with repeaters in your area can be used in Simplex mode for normal direct radio-to-radio communications.

### To enable duplex on a repeater channel:

1. Select the required repeater channel (1 - 8, 41 - 48).
2. Briefly press the **DUP** key. The  icon will appear on the display accompanied by a high beep.

### To remove duplex from a repeater channel:

1. Select the required repeater channel (1 - 8, 41 - 48). If duplex is currently selected, the  icon will be displayed.
2. Briefly press the **DUP** key. The  icon will disappear from the display accompanied by a low beep.

**NOTE:** Channels 1 - 8, 31 - 38, 41 - 48 and 71 - 78 should only be used in Simplex mode if there are no repeaters in or near your location that operate on the selected channel. In particular, avoid operating in Simplex mode on any of the repeater input channels 31 - 38 and 71 - 78 unless you are absolutely sure that there are no repeaters in range using that channel. Inadvertently transmitting on an active repeater input frequency in simplex mode could cause interference to other users on that repeater who might not be audible to your radio.

## PRIORITY CHANNEL

---

The Priority channel feature allows you to instantly recall any one of the 80 CB channels in your radio. This feature can be used to provide instant access to your working channel or your local repeater channel at the press of key. It is also used in conjunction with the Priority Scan mode.

### To store a priority channel:

1. Select the required channel.
2. Press and hold the **PRI** key.  
The channel number will flash for a few seconds then a high beep will be heard as the channel is stored. The 'PRI' icon will now be visible whenever that channel is selected.

**NOTE:** The Priority channel can also be set through the Menu.

### To recall a priority channel:

Briefly press the **PRI** key. The radio will immediately switch to the Priority channel and the 'PRI' icon will be displayed.

**NOTE:** If the radio was scanning when the Priority channel was recalled, the scan will be cancelled.

## SCANNING

Your radio incorporates a scan function allowing selected groups of channels to be scanned for signals. Channels can be scanned at a rate of 50 channels per second.

When a signal is found, scanning will pause to allow the signal to be heard then resume scanning when the channel is clear again.

### SCAN GROUPS

---

Your radio supports three scan groups:

- **Open Scan:** Allows you sequentially scan from 2 to 80 user-selectable CB channels.
- **Priority Scan:** Allows you constantly monitor your priority channel while scanning a group of user-selectable CB channels.
- **Network Scan:** Allows a group of radio users to maintain communications even when the band is congested by monitoring a small group of user selectable channels. If the operating channel becomes busy with users from outside your group, Net-Scan will automatically select a new free channel from the scan group and transparently switch all users in your group to the new channel.

### To select open scan/priority scan/network scan:





1. Press the **MENU** key.
2. Navigate to select **SCAN SETTINGS**, and the required scan option.

## PROGRAMMING THE SCAN MEMORIES

---

Each Scan Group has its own separate channel memory allowing you complete freedom to program your choice of channels into each group.

### To add/remove channels from the selected scan memory:

1. Select the required channel using the **▲** or **▼** key.
2. Check to see if the  icon is displayed on that channel.
  - If  is displayed, the selected channel is already in the scan memory. To remove it, press and hold **SCAN**. A low beep will be heard and  will disappear.
  - If  is not displayed, the selected channel is not in the scan memory. To add it, press and hold **SCAN**. A high beep will be heard and  will appear on that channel.

Repeat to add or remove other channels in the scan memory.

**NOTE:** When adding channels to Net-Scan, please consider the following:

- The transmitter on your radio is inhibited on channels 22, 23 and channels 61, 62, 63 as required by the ACMA. This makes these channels unsuitable for use as Net-Scan channels.
- You should not include any repeater channel unless you have confirmed that the channel is not allocated to repeaters in your area. Using an active repeater channel in Net-Scan may result in interference to repeater users on that channel.

## AUTO SKIP

---

While scanning, if an active channel in your Scan Group becomes a nuisance by constantly interrupting the scan, briefly press **▲** or **▼** while the radio is paused on that channel. The busy channel will be temporarily removed from the Scan Group to allow time for the channel to become clear again and scanning will continue from the next channel in the sequence. After 30 seconds the skipped channel will be reinstated in the scan sequence.

If the unwanted active channel continues to interrupt the scan even after the 30 second skip period has elapsed, hold SCAN while the radio is paused on that channel. The 'nuisance' channel will be completely removed from the Scan Group for the duration of that scan session. To restore the channel, simply stop and restart the scan session using the SCAN key (or switch the radio Off then On again).

NOTE: You can skip as many busy channels from the Scan Group as you wish, however if you attempt to skip the last remaining channel, all the previously skipped channels will be restored to the Scan Group.

The length of the skip period can be adjusted through the XRS Connect App.

## DUAL WATCH

---

The Dual Watch mode allows you to monitor two channels at the same time. While in dual watch mode, the unit will monitor both the working channel and the priority channel.

You will need to assign one of the programmable buttons to Dual Watch to use this feature.

### To start the dual watch mode:

1. Use the **▲** or **▼** keys to choose the selected channel.
2. Press or hold (depends on how the key is configured for your radio) the assigned programmable key until the radio beeps.
3. 'DW' is displayed and the SCAN icon will animate.

You can change your working channel by pressing the Channel Up and Channel Down keys.

To exit Dual Watch, press or hold your programmable button (depends on how the key is configured for your radio), or press the **SCAN** button.

## OPEN SCAN

---

Open Scan allows a group of channels to be scanned in an ascending sequence. If a signal is found, the scan will pause on that channel. During this time you can press the **PTT** on the microphone and talk on the channel. Once the channel has been clear for 5 seconds the scan will resume.

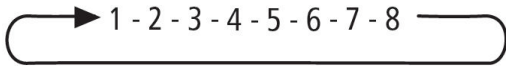

## SELECTING OPEN SCAN

---

### To select open scan:

1. Press the **MENU** key.
2. Navigate to select **SCAN SETTINGS**.

The default working channel is in the Open Scan mode.

In the Open Scan mode, your default working channel is the channel your radio switches to when you press the **PTT** while scanning. To set your working channel simply select the required channel before you press **SCAN**. e.g. to make channel 24 your working channel, simply select channel 24 before pressing **SCAN**.

### To begin scanning:

Briefly press **SCAN**. A high beep will be heard, 'SCANNING' will be displayed and the  icon will animate. During this time the scan mode and the number of channels being scanned will be displayed along with the selected Zone.

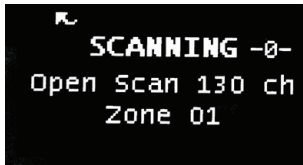

If there are less than 2 channels programmed into the scan memory when you press **SCAN**, a low beep will be heard and the command will be ignored.

## Operating in the Open Scan Mode

If a busy channel is found, scanning will pause to allow the signal to be heard and will remain there for as long as the channel remains busy. Once the channel has been clear for 5 seconds, scanning will resume automatically.

If you don't wish to listen to a busy channel, briefly press **▲** or **▼** while the radio is paused on that channel. The busy channel will be temporarily removed from the Scan Group to allow time for the channel to become clear again and scanning will continue. The skipped channel will be reinstated in the scan sequence after 30 seconds (see Auto Skip).

If you press the PTT while the radio is scanning, the scan will pause and the radio will transmit on the working channel.

After the channel has remained clear for 5 seconds scanning will resume.

If your radio pauses on a busy channel and you wish to talk on that channel, wait for a break in the conversation then press the **PTT**. If the busy channel was not your working channel, it now becomes your working channel, replacing your previous working channel. Once your communication has finished and the channel has been clear for 5 seconds, scanning will resume.

If you need to use your Priority channel at any time, briefly press **PRI**. The scan will be cancelled and the radio will jump straight to the Priority channel.

## PRIORITY SCAN

---

Priority Scan allows you to scan a number of channels for activity while also monitoring your Priority channel. The receiver will scan the other channels **only while there is no signal on the priority channel**. If a signal appears on the Priority channel it will override any signals being received on any of the other channels. In addition, if you press the **PTT** at any time, the radio will transmit on the Priority channel.



Example: Scanning channels 1 - 8 with priority channel 20 in Priority Scan

**NOTE:** By default the priority channel will be scanned after every 5th scan channel. This timing can be adjusted using the XRS Connect App.



## SELECTING PRIORITY SCAN

---

To select Priority Scan, refer to the Menu/Scan Settings options.

### To begin scanning:

Briefly press **SCAN**. A high beep will be heard, 'SCANNING' will be displayed and the  icon will animate. During this time the scan mode and the number of channels being scanned will be displayed along with the selected Zone.

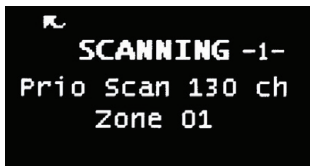

- If a signal appears on the Priority channel - at any time - the radio will switch directly to the Priority channel and will stay there for as long as the channel remains busy. During this time you can transmit and receive on the Priority channel.

Once the Priority channel has been clear for 5 seconds the radio will resume scanning the other channels.

- If a signal appears on any other channel, scanning will pause on that channel and will remain there while the channel is busy - as long as there are no signals on the Priority channel.

During this time, the receiver will continue to check the Priority channel every 2 seconds resulting in a series of small breaks in the reception. Once the signal has gone and there has been no activity for 5 seconds, the radio will resume scanning.

- If the radio is paused on a busy channel and you want to remain there, briefly press **SCAN**. The radio will exit scan and remain on the busy channel. At this point you will no longer be monitoring the Priority channel.

To resume the Priority Scan, press **SCAN** again.

- If you don't wish to listen to a busy channel, briefly press the **▲** or **▼** key while the radio is paused on that channel. The busy channel will be temporarily removed from the Scan Group to allow time for the channel

to become clear again and scanning will continue. The skipped channel will be automatically reinstated in the scan sequence after 30 seconds (see 'Auto skip').

- To transmit on the Priority channel at any time, simply press the **PTT**. The radio will switch straight to the Priority channel.

When you have finished your conversation and there has been no further activity for 5 seconds, the radio will resume scanning the other channels.

To jump straight to the Priority channel at any time, briefly press the **PRI** key. The scan will be cancelled.

## **NETWORK SCAN (NET-SCAN)**

---

Net-Scan allows a group of radio users to maintain communications even when the band is congested.

To achieve this, all members of the Net-Scan group must share a common CTCSS/DCS code and a common set of scan channels.

Once activated, Net-Scan's intelligent scanning software keeps track of clear channels within your Scan Group. When any member of the group first transmits, their radio automatically selects a clear channel to transmit on. Other radios scanning in the same Net-Scan group will detect the common CTCSS/DCS code and lock onto that channel allowing all members of the group to join the conversation.

If a signal from outside your Net-Scan group transmits on the selected channel without using your chosen CTCSS/DCS code, the group will automatically switch to a new clear channel at the next transmission. In this way the group can continue to communicate with minimal interference to or from other users.

## **ENABLING NET-SCAN**

---

### **To select network scan and a suitable CTCSS/DCS code:**

1. Press the **MENU** key.
2. Navigate through the menu to select **SCAN SETTINGS** and choose from the options available.

## USING NET-SCAN

---

With Net-Scan mode enabled, briefly press **SCAN**. A high beep will be heard, 'SCANNING' will be displayed and the  icon will animate. During this time the scan mode and the number of channels being scanned will be displayed along with the selected Zone.

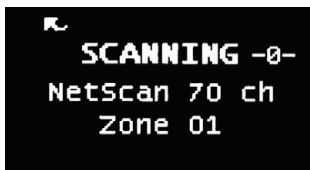

When a member of the group initiates a transmission their radio will automatically select a clear Net-Scan channel to transmit on.

Other radios scanning in the same Net-Scan group will locate the transmission by identifying the groups CTCSS/DCS code, pause on that channel and open their Squelch, allowing the transmission to be heard across the entire group. When the transmission ends, all radios in the group will immediately resume scanning.

If a member of the group responds to the initial transmission, they will automatically re-use the same channel as long as the channel remains free of other signals. This allows the radios in the group to respond more quickly to further transmissions from others in the group.

If at any time a signal from outside your Net-Scan group transmits on the selected channel without using your chosen CTCSS/DCS code, the channel will be discarded and a new clear channel will be selected at the next transmission. The other radios in the group will then relocate to the new channel allowing the conversation to continue seamlessly without any input from the user.

## ENDING THE SCAN

---

To stop scanning, briefly press **SCAN**. A low beep will be heard and the  icon will stop animating. As long as the radio was not on a busy channel, it will return to the last channel you selected, otherwise it will stay on the busy channel.

## CTCSS AND DCS

The standard Squelch system operates solely on signal strength which means that it will open to any signal that is strong enough. If the selected channel is busy with other stations the Squelch will be opening constantly making it difficult to determine which calls are meant for you.

CTCSS (Continuous Tone Coded Squelch System) and DCS (Digital Coded Squelch) are similar Squelch quieting systems that provide selective audio muting using sub-audible signalling. When CTCSS or DCS is enabled, only signals with a matching sub-tone will be heard in the speaker. This effectively creates a channel that is silent to all traffic except those you wish to hear.

### CHOOSING CTCSS OR DCS

---

The CTCSS system uses 1 of 50 low frequency tones to open and close the Squelch on the radio. The DCS system is similar to CTCSS but uses 1 of 104 digital codes to control the Squelch. There is no difference in performance or function between CTCSS or DCS so choosing which system to use will largely depend on the other radios you talk with. If others already use CTCSS or DCS, you should select the system that matches theirs. If the users you talk to don't currently use CTCSS or DCS then you can make your own choice. Both types are included in the radio to maintain compatibility with other radio systems.

### CTCSS TONE SET COMPATIBILITY

---

The GME CTCSS tone set comprises 50 tones made up of the standard CCIR-38 Tone Set plus an additional 12 tones added to the end. If communicating with other brands of radios that only use the CCIR-38 tone set, please select from one of the first 38 tones to ensure compatibility with these radios.

If communicating with other GME radios, you may choose from any of the 50 tones. However, to ensure compatibility, please refer to the tone set table listed in each radio's Instruction manual because the tones used in older GME models may be listed in a different order to those in your radio.

To select a CTCSS or DCS code, refer the Menu/Radio Settings options.

## **ENABLING CTCSS/DCS ON A CHANNEL (SILENT MODE)**

---

Enabling CTCSS/DCS on a channel will prevent the Squelch from opening on that channel unless the incoming signal matches your selected CTCSS/DCS tone. Other users on the same channel who are not using your CTCSS/DCS tone will still be received by your radio (the  icon will still appear on the display) but they will not be heard in the speaker.

Only when someone transmits on the channel using your CTCSS/DCS tone will the Squelch open to allow the signal to be heard. Channels where CTCSS/DCS have been enabled are said to be in 'Silent mode'.

**NOTE:** Silent mode can be enabled on any channel except emergency channels 5 and 35.

### **To enable silent mode on a channel:**

1. Press the **MENU** key.
2. Navigate through the menu to select **FUNCTIONS > TOGGLE SILENT**.
3. Press the **MENU** key to select **ON**.

An **S** icon (CTCSS) or **S**  icon (DCS) will be displayed at the top of the display to indicate Silent mode is now enabled on that channel.

**NOTE:** You cannot enable Silent mode unless a CTCSS or DCS tone has been selected in the 'RADIO SETTINGS' menu. If CTCSS/DCS has been set to OFF, Silent mode is inhibited.

### **To disable silent mode on a channel**

1. Press the **MENU** key.
2. Navigate through the menu to select **FUNCTIONS > TOGGLE SILENT**.
3. Press the **MENU** key to select OFF.
4. The **S** icon (CTCSS) or **S**  icon (DCS) will disappear from the display to confirm Silent mode is now disabled on that channel.



**NOTE:** When Silent mode is enabled on a channel you should always check the icon for signs of traffic on the channel before transmitting to ensure you do not accidentally transmit over the top of another user. Alternatively, you can enable

Busy Lockout in the menu which will automatically prevent your radio from transmitting if the channel is already in use.

## BUSY LOCKOUT

---

When using Silent mode with CTCSS/DCS, your radio's receiver remains quiet to all signals outside your CTCSS/ DCS group. As a result, if you do not notice when others are transmitting on your channel you could accidentally transmit over the top of them.

The Busy Lockout function detects when others outside your CTCSS/DCS group are transmitting on the channel and prevents your radio from transmitting over them. If you press the PTT when the channel is busy the radio will emit a warning beep and the  icon won't be displayed. If this happens, look for the  icon on the display as an indicator that the channel is in use. If the channel is busy, simply wait until the channel is clear and press the PTT again.

### To enable or disable busy lockout:

1. Press the **MENU** key.
2. Navigate through the menu to select **RADIO SETTINGS > BUSY LOCK**.



Use the **MENU** key to enable or disable this feature.

**NOTE:** A 'Busy Lockout Override with CTCSS Match' option is available through the XRS Connect App. When this option is enabled, Busy Lockout will not prevent you from transmitting over the top of another signal where their CTCSS/DCS code matches yours (i.e. The signal is from a member of your group).

## MONITOR FUNCTION

---

When the current channel is in Silent mode, you may see the  icon appear but hear no sound in the speaker. This indicates that your radio is receiving a signal that does not match your CTCSS/DCS tone.

Press the  key to briefly monitor signals on the channel. The Silent mode will be temporarily disabled while the  key is pressed allowing you to hear signals on the channel. When you release the  key, Silent mode is restored and the radio becomes quiet again.

**NOTE:** You will only have a brief moment to monitor the channel for signals because holding the **I** key for more than a few seconds will switch the radio off.

## SELECTIVE CALLING

Your radio has a Selective Calling system known as SelCall that operates like a telephone. Your radio is pre-programmed with its own unique SelCall Identification number. If this number is called by another radio, your radio will beep to alert you. If you do not want to hear any other activity while waiting on a channel, you can select the QUIET mode. Your radio will then remain quiet to all incoming signals until your SelCall number is called.

You can store up to 20 of your most frequently called SelCall numbers in memory and each number can be labelled for easy identification.

### SELCALL IDENTIFICATION NUMBER

---

Your radio is factory programmed with its own unique SelCall Identification Number. This number identifies your radio from others in your area. Your radio's own SelCall Ident will be displayed for a few seconds to the lower-left of the display when you first turn the radio on. You will need to make your Ident known to anyone who may need to call you using SelCall.

**NOTE:** Although your radio is factory-programmed with a unique SelCall Ident, you can change your Ident to another number if required, using the Menu/Selcall option.

### SELCALL NAMING

---

When storing SelCall numbers, you can add names to each one to make it easier to identify whose number you are recalling. In addition, if an incoming SelCall matches one of your stored numbers, the name will be displayed to identify the caller.

## THE QUIET MODE

---

Your radio can be set to monitor signals on a busy channel but remain Quiet unless it receives its own SelCall Ident.

In this way, you won't be disturbed unless someone calls you. When your SelCall Ident is received, the Quiet mode is deactivated and an alarm sounds to alert you to the call. You can then converse normally on the channel.

**NOTE:** The QUIET mode overrides the normal active mute system to ensure that the radio remains quiet even when the channel is busy. When QUIET is set, you may see the  icon appear on the display indicating the channel is being used. However, unless someone transmits your SelCall Ident, nothing will be heard in the speaker.

You can activate the QUIET mode on individual channels (i.e. Some channels can be set to remain Quiet while others can remain open to all incoming signals) by storing those channels into a Quiet Memory.

## SENDING A SELCALL

---

**To send, program or change a SelCall number:**

1. Press the **MENU** key.
2. Select **SELCALL** and its options.

## RECEIVING A SELCALL

---

When your radio receives its own SelCall number, the  icon will appear along with the callers SelCall number and name and the radio will sound an alarm to alert you to the call. During this time the alarm will beep urgently and the Quiet mode (if enabled) will open to allow incoming calls to be heard. After 30 seconds, if the call is not answered, the alarm will slow and the Quiet mode will be reactivated. The alarm will then continue to beep slowly until you cancel it.

**To cancel the alarm, but leave the incoming SelCall Ident on the display:**

Briefly press the TOP key on the top of the microphone. The alarm will stop but the caller's name and SelCall number will remain on the display and the channel will remain open to any incoming signals. This feature is useful if you are currently busy but intend to call the person back later.



### **To cancel the alarm and talk on the channel:**

Press the **PTT** and talk in the usual way. The alarm will be canceled, the display will return to normal and the channel will be open for normal communication.

### **To clear the alarm completely:**

Briefly press **BACK**. The alarm will be canceled and the display will return to the normal screen.

## **QUIET MODE**

---

The Quiet mode mutes the receiver to prevent incoming signals from being heard in the speaker until your SelCall Ident is received. In this way you can monitor a busy channel for personal calls without being disturbed by unwanted signals. If your SelCall number is received, the Quiet mode is cancelled and all incoming signals are heard in the speaker.

### **Setting up the Quiet mode**

To setup the Quiet mode you must first store the individual channels that you want to stay quiet into the Quiet memory. When the required channels are stored, simply activate the Quiet mode and all stored channels will remain quiet to all incoming signals unless your SelCall Ident is received.

Channels not stored in the Quiet memory will remain open to all signals and will operate normally.

### **To store individual channels into quiet memory:**

1. Select the required channel.
2. Press the **MENU** key, and select **FUNCTIONS**.
3. Select **TOGGLE Q MEM** and press **MENU** to select **ON** or **OFF**.

When Quiet memory is switched 'ON' on the selected channel, 'Q' will appear at the top of the display indicating the selected channel is now stored in the Quiet memory.

When Quiet memory is switched OFF on the selected channel, 'Q' will disappear from the display indicating the channel is no longer stored in the Quiet memory.

## Activating the Quiet mode

1. Select a channel that has been stored in the Quiet memory. 'Q' will be displayed.  
**NOTE:** You cannot activate the Quiet mode unless you have selected a stored channel.
2. Press the **MENU** key, and navigate to select **FUNCTIONS > TOGGLE QMode**.
3. Press the **MENU** key to select from the **ON** or **OFF** options.

When Quiet mode is switched ON,  will appear at the top of the display indicating that Quiet operation is enabled. Now, all channels stored in the Quiet memory will be operating in the Quiet mode.

When Quiet mode is switched OFF,  will disappear from the display indicating that Quiet operation is disabled. Now, all channels stored in the Quiet memory will be open for signals.

## Receiving signals in the Quiet mode

- If a normal signal is received on a Quiet channel, the channel will appear busy (the  icon will be visible) but no sound will be heard from the speaker.
- If a normal signal is received on an Open channel (one that is not in the Quiet memory) the signal will be heard in the usual way.
- If your SelCall Ident is received on any channel - Open or QUIET - the Quiet mode will be cancelled and the alarm will beep to alert you to the call. In addition, the caller's name and number will be displayed. All channels will now be open for normal transmission and reception.

## Scanning in the Quiet mode

The radio will allow you to scan while the QUIET mode is active. Using this feature you can monitor a group of Quiet channels or a combination of Quiet and Open channels.

**NOTE:** To ensure reliable SelCall detection when scanning in the Quiet mode, it is recommended that you restrict the number of channels in the Scan Group.

## GROUP CALLING

The SelCall system includes a Group Call function that allows you to call up to 1000 radios simultaneously. This can be useful in an emergency situation where you may need to transmit a message to a large number of radios in your group.

By default, your radio is factory-set to allow up to 10 radios to be called at once. If your application requires more, your dealer can re-program this option to allow 100 or even 1000 radios to be called. The following description assumes the default Group Call setting of 10 radios.

The Group Call function works by allowing you to enter a special 'group code' into the last digit of the SelCall number you are sending. The 'group code' appears as an 'A' (All) when displayed in the radio. When this 'group code' is received, it substitutes for all other numbers in that position. As long as the first 4 digits of the SelCall you are sending match those of the radios you are calling, their SelCall alarm will be activated as if their full 5 digit SelCall Idents had been received.

To achieve this, the 10 radios you are calling have sequentially numbered SelCall Idents.

e.g. 14530, 14531, 14532, 14533, 14534, 14535, 14536, 14537, 14538, 14539

Transmitting the SelCall Ident 14531 will only activate the alarm in the radio with the SelCall Ident of 14531. However, transmitting 1453A will activate the alarms in all radios with Idents 14530 through 14539 (a total of 10 radios).

If the radios in your fleet do not have sequential SelCall number and you want to make use of this function, you will need to re-program the SelCall Idents in your radios by changing the numbers in your radio's 'OWN' SelCall memory.

## PROGRAMMING AND SENDING GROUP CALLS

The process for entering a Group Call Ident is the same as entering a normal SelCall Ident.

1. Press the **MENU** key.
2. Use the **▲** or **▼** keys to select **SELCALL** and press **MENU** to select.
3. Select **MAKE SELCALL** and press **MENU**.
4. Use the **▲** or **▼** keys to change the digit at the cursor position. Press **MENU [SEL:NEXT]** to step forward to the NEXT digit position or **BACK** to step back to the previous digit position.

5. Repeat until the first 4 digits have been entered. At the last digit use the **▲** or **▼** keys to select 'A'.
6. Hold **MENU [HLD:CALL]** to send.

The  icon will be display as the SelCall is transmitted.

**NOTE:** Where your radio allows it, programming Group Calls for 100 radios is identical except that you will need to select 'A' for the last two digits (e.g. 123AA). For 1000 radios you will need to select 'A' for last three digits (e.g. 12AAA).

## **CALL ACKNOWLEDGE IN GROUP MODE**

---

There is no Call Acknowledge when sending Group Calls. This is to prevent all the radios in your group from trying to respond to your SelCall transmission at the same time.

## **STORING GROUP CALL IDENTS**

---

Group Call Idents can be stored in memory in the same way as a standard SelCall Ident.

## **RECEIVING GROUP CALLS**

---

Receiving a Group Call is identical to receiving a normal SelCall except that the alarm sound is a LOW tone beep instead of the normal High tone beep. The caller's name and number is displayed in the usual way.

## MENU OPTIONS

The Menu provides access to all the settings, adjustments and functions listed in the table below. All menu items are controlled using the **MENU**, **▲**, **▼** and **BACK** keys.

1. To access the menu, press the **MENU** key.
2. To scroll through the list of menu items press the **▲** or **▼** keys.
3. To select an item, press the **MENU** key.
4. To step back through the menu, or to exit the current screen, HOLD the **BACK** key.

A context menu is included at the bottom of each screen. The options offered will change depending on the selected topic.

SEL:OPTION = Briefly press the **MENU** key to select the option.

HLD:OPTION = Press and hold the **MENU** key to select the option.

### CONTEXT MENU EXAMPLES

---

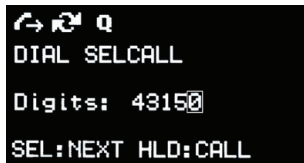

SEL:NEXT =

Press **MENU** for NEXT

HLD:CALL =

Hold **MENU** for CALL

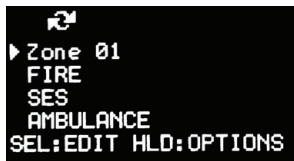

SEL:EDIT =

Press **MENU** for EDIT

HLD:OPTIONS =

Hold **MENU** for OPTIONS

When entering text (e.g. zone names or SelCall numbers), the following characters are available;

Text	Available
<b>Uppercase Letters</b>	A B C D E F G H I J K L M N O P Q R S T U V W X Y Z
<b>Lowercase Letters</b>	a b c d e f g h i j k l m n o p q r s t u v w x y z
<b>Numbers</b>	0 1 2 3 4 5 6 7 8 9
<b>Punctuation</b>	. * + <space>

## MENU TABLE

Menu	Options	Option Settings
<b>ZONES</b>	Zone 01 Zone 02 Zone 03 Zone 04 Zone 05 Zone 06 Zone 07 Zone 08	GO/EDIT
<b>BLUETOOTH</b>	Secure pair Pair	ON/OFF
<b>PROG BUTTONS</b>	XRS BUTTON PRESS XRS BUTTON HOLD TOP BUTTON HOLD	DISPLAY DIM CB SCAN MEMORY QUIET MEM QUIET MODE SCRAMBLER SQUELCH LEVEL ZONES VOICE PLAYBACK ACTIVE MUTE DUAL WATCH SELCALL RESEND LOC TX TOGGLE
	TOP BUTTON PRESS	CYCLE SCAN CHANNEL SELCALL VOICE PLAYBACK ACTIVE MUTE DUAL WATCH
<b>FUNCTIONS</b>	TOGGLE Q MEMORY TOGGLE Qmode TOGGLE SCAN TOGGLE SILENT	ON/OFF

Menu	Options		Option Settings
<b>RADIO SETTINGS</b>	AUTO POWER	TIMEOUT	30-180 min/None
		RECV RESETS	ON/OFF
		B'TOOTH HALTS	ON/OFF
	BEEP VOLUME		0 to 10
	BRIGHTNESS		0 to 10
	BUSY LOCKOUT		ON/OFF
	CB SUBTONE		CTCSS/DCS Tones
	DISPLAY		None / Volts / S-Lin / S-Met
	DYNAMIC VOLUME CONTROL		ON/OFF
	MIC GAIN		+0dB to +9dB
	PRIORITY CHANNEL		CB01 to CB80
	ROGER BEEP		ON/OFF
	SCRAMBLER		ON/OFF
	SPEAKER		Radio, Mic, Both
	SQUELCH LEVEL		1 to 9
	SQUELCH TAIL		ON/OFF
	SELCALL ACK		ON/OFF
	VERSIONS		Model, Serial #, Firmware, Bluetooth H/W, Bluetooth F/W
RESET SETTINGS		Cancel, Reset radio, Factory Reset	
<b>SCAN SETTINGS</b>	CB SCAN MEMORY		A Open Scan B Priority Scan C Network Scan
	NETSCAN SUBTONE		CTCSS/DCS
<b>SELCALL</b>	MAKE SELCALL Last Own Memory - 20		



Menu	Options	Option Settings
XRS FEATURES > LOCATION SERVICES	LOCATION TX	ON/OFF
	LOC SOURCE (MC668)	GPS/App+
	SET ID/STATUS	User ID/Status
	LOC TIMEOUT	None - 180 minutes '30 minutes' is the default option.
	MIC DISPLAY	Loc/Txt/Off
	GPS DISPLAY (MC668)	ON/OFF
	SELCALL UID	ON/OFF
	TX DATA LIMIT	ON/OFF
	SHOW OWN LOC (MC668)	Longitude/Latitude/Elevation
XRS FEATURES > VOICE PLAYBACK	ENABLE	ON/OFF
	CLEAR ALL	-
	PLAYBACK	-
XRS FEATURES > ACTIVE MUTE	MUTE TIMEOUT	None - 180 minutes; '30 minutes' is the default option
	REDUCE VOLUME	Mute, 75%, 50%, or 25% reduction in current volume; 'Mute' is the default option

## RECEIVE-ONLY CHANNELS (ZONES)

Your XRS Connect radio can store up to 400 user-programmable receive-only channels within the frequency range of 403 MHz to 520 MHz. Channels are stored in one of 8 zones with each zone containing up to 50 channels. Zones and channels can each be individually named for easy identification.

Programming is done either through the radio menu or through the GME XRS Connect App. The XRS Connect App also offers a range of pre-programmed frequencies in various categories sorted by locations making the selection of suitable channels and frequencies much easier.

When a Zone is selected, its frequencies will be added to the standard 80 CB channels. Zone channels appear immediately above CH80. After the last zone channel is selected channels will wrap around to CH01 again.



## SELECT A ZONE

---

1. Press the **MENU** button.
2. Select **ZONES** and press **MENU**.
3. Select the desired zone from the Zone list.

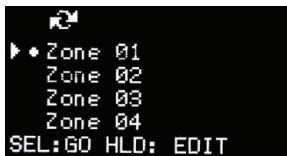

4. Press **MENU** [SEL:GO].

## EDIT A ZONE NAME

---

1. Press the **MENU** key.
2. Select **ZONES** and press **MENU**.
3. Select the desired Zone from the Zone list. To edit the zone, select HOLD the **MENU** key [HLD:EDIT].  
The zone edit screen appears.

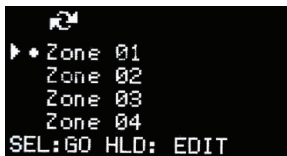

4. Press **MENU** [SEL:EDIT] to edit the zone name.

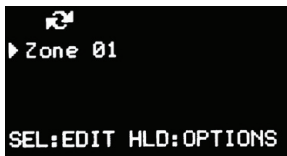

5. Use the **▲** or **▼** keys to change the character at the cursor position.
6. Press the **MENU** key to step forward to the NEXT character position or the **BACK** key to step back to the previous character position.

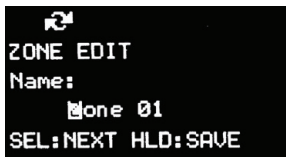

7. Continue until the desired name has been entered. Zone names can be up to 16 characters long.

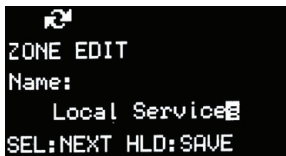

8. To save the name HOLD the **MENU** key (HLD:SAVE).

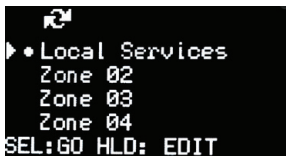

The radio will return to the Zone list with the new zone name displayed.



The radio returns to the main screen with the selected zone displayed below the channel number.

All channels in the selected zone will now be available along with the usual 80 CB channels. Zone channels can be found immediately above CB Channel 80.

## ADD CHANNELS TO A ZONE

---

1. Press the **MENU** key.
2. Select **ZONES** and press **MENU**.
3. Select the desired Zone from the Zone list and HOLD **MENU** (HLD:EDIT) to edit the zone.

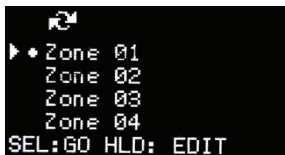

4. Hold **MENU** (HLD:OPTIONS) to select Options.

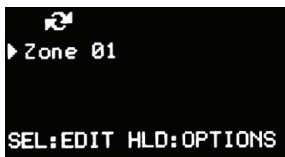

5. Use the **▲** or **▼** keys to select **ADD CHANNEL** from the menu list.
6. Press **MENU** (SEL:EDIT) to edit the new channel.



- Use the **▲** or **▼** keys to change the character at the cursor position.
- Press **MENU** to step forward to the NEXT character position or the **BACK** key to step back to the previous character position.
- When the desired name has been entered, press the **MENU** key repeatedly to step to the RX frequency. Channel names may contain up to 16 characters.



- To save the new channel, hold **MENU** [HLD:SAVE].



The display returns to the Zone screen.

## EDIT EXISTING CHANNELS IN A ZONE

---

- Press the **MENU** key.
- Select **ZONES** and press **MENU**.
- Select the desired Zone from the Zone list and hold **MENU** [HLD:EDIT] to edit the zone.

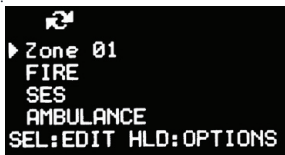

- Use the **▲** or **▼** keys to select a channel
- Hold **MENU** [HLD:OPTIONS] for the Options menu.

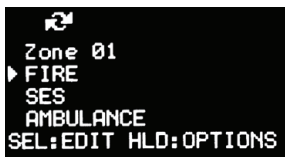

- Use the **▲** or **▼** keys to select from the options list then press **MENU**.
  - Select **Go Channel** to jump to the select channel
  - Select **Del Channel** to delete the selected channel
  - Select **Add Channel** to add a new channel
  - Select **Edit** to edit the selected channel



- Next select **MENU** [SEL:EDIT].
- To add a new channel or **EDIT** an existing channel;
- Use the **▲** or **▼** keys to change the character or digit at the cursor position.
- Press **MENU** to step forward to the NEXT character or digit position or the BACK key to step back to the previous character or digit position.



11. Continue until the name or frequency has been edited.
12. Hold **MENU** [HLD:SAVE] to save.

## BLUETOOTH

---

### Secure Pairing

Use this to turn secure PIN pairing on or off for your Bluetooth connection. If Secure Pairing is turned on when pairing your mobile device with the XRS Connect radio for the first time, you will be asked to confirm a security PIN on both the mobile device with the XRS Connect app and your radio.

With Secure Pair turned on you must put the radio into Pair mode using the PAIR menu option, before connecting your XRS Connect app.

### Pair

When Secure Pairing is turned on you must select PAIR in the Bluetooth menu to put the radio into pair mode before you can connect for the first time. Pair mode will timeout after 90 seconds.

## PROGRAMMABLE BUTTONS

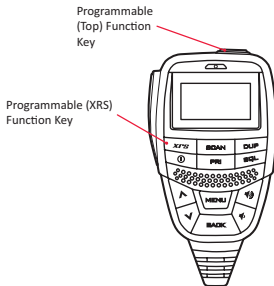

Menu	Options	
XRS button press	Display Dim	Dims the display and keypad backlight.
	CB Scan Memory	Cycles through the three scan memories.
XRS button hold	Quiet Memory	Stores channels in the SelCall Quiet memory.
Top button hold	Quiet Mode	Toggles SelCall Quiet mode between on or off.
	Scrambler	Enables or disables the scrambler option.
	Squelch Level	Adjusts the preset squelch level in steps from 1 to 9.
	Zones	Displays the Zone list menu for quick zone selection.
	Voice Playback	Plays back recorded transmissions.
	Active Mute	Mutes/reduces the volume of the radio/unmutes the radio, based on how the Active Mute feature is set.
	Dual Watch	Allows you to monitor a selected channel and the Priority Channel simultaneously.
	SelCall Resend	Automatically resends to the last Selcall ID you sent.
	Loc TX Toggle	Toggles whether your location is transmitted when you PTT.



Menu	Options	
Top button press	Cycle Scan Channel	Cycles through the channels stored in the current scan memory.
	SelCall Call function	Provides the standard Call button functions i.e. Press to enter SelCall entry menu Hold to send last SelCall.
	Voice Playback	Plays back recorded transmissions.
	Active Mute	Mutes/reduces the volume of the radio/unmutes the radio, based on how the Active Mute feature is set.
	Dual Watch	Allows you to monitor a selected channel and the Priority channel simultaneously.

1. Press the **MENU** key.
2. Use the **▲** or **▼** keys to select **PROG BUTTONS** then press **MENU** to select.
3. Use the **▲** or **▼** keys to select the desired programable button then press **MENU**.



4. The XRS Button option list is displayed. The currently selected option is marked with a dot. Use the **▲** or **▼** keys to select to desired option then press **MENU** to select.



5. Press **BACK** to exit back to the previous menu or hold **BACK** to return to the main screen.

## FUNCTIONS

---

The Function option allows you to set the state of several functions related to Scan, SelCall and CTCSS/DCS.

1. Press the **MENU** key.
2. Use the **▲** or **▼** keys to select **FUNCTIONS** then press **MENU**.
3. Use the **▲** or **▼** keys to select from one of the options below;
  - **TOGGLE 'Q' MEM**: Store channels in the SelCall Quiet memory.
  - **TOGGLE Qmode**: Toggle Quiet mode for SelCall.
  - **TOGGLE SCAN**: Enable/Disable the Scan function.
  - **TOGGLE SILENT**: Toggle Silent mode for CTCSS/DCS channels.  
Press **MENU** to toggle the selected function ON or OFF.

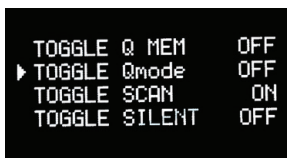

4. Press **BACK** to exit back to the previous menu or hold the **BACK** key to return to the main screen.

## RADIO SETTINGS

---

1. Press the **MENU** key.
2. Use the **▲** or **▼** keys to select **RADIO SETTINGS** then press **MENU**.
3. Use the **▲** or **▼** keys to select from one of the setting options (see the options table below).
4. To alter a value (e.g. Beep Volume) press **MENU** then use the **▲** or **▼** keys to adjust the value. Press **MENU** to accept. To toggle an ON/OFF setting, press **MENU**.

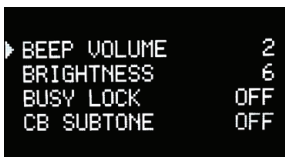

▶ BEEP VOLUME	2
BRIGHTNESS	6
BUSY LOCK	OFF
CB SUBTONE	OFF

5. Press **BACK** to return to the previous menu or hold the **BACK** key to return to the main screen.

## Radio Setting Options Table

Menu	DESCRIPTION	OPTIONS
<b>AUTO POWER</b>	Turns the radio off after a time period specified by the user.	None/30-180 ON/OFF ON/OFF
<b>BEEP VOLUME</b>	Adjusts the volume of the key press beeps.	0 to 10 [4]
<b>BRIGHTNESS</b>	Adjusts the OLED and keypad brightness.	0 to 10 [5]
<b>BUSY LOCK</b>	Disables the transmitter when the radio is busy to prevent you from transmitting over the top of other users	ON/OFF [OFF]
<b>CB SUBTONE</b>	Switches the CTCSS or DCS tone Off or ON and sets the tone frequency.	OFF [OFF] CTC01 – CTC50 DT001 – DT104
<b>DISPLAY</b>	Displays the supply voltage level, or the signal strength meter reading (logarithmic/linear).	None / Volts / S-Lin / S-Met
<b>DYNAMIC VOL</b>	Balances the volume level of incoming signals so that soft and loud signals have a similar volume.	ON/OFF [ON]
<b>MIC GAIN</b>	Adjusts the microphone's sensitivity. Increase the gain for quiet voices. Decrease the gain for loud voices or for use in noisy environments.	+0dB to +9dB [+0dB]
<b>PRIORITY CH</b>	Sets the channel that is selected when the PRI key is pressed.	CB01 – CB80 [CB01]
<b>ROGER BEEP</b>	Automatically transmits a tone whenever the PTT is released.	ON/OFF
<b>SCRAMBLER</b>	Enables/Disables the Scrambler option	ON/OFF [OFF]
<b>SPEAKER</b>	Selects which speakers are in use. Sounds can be heard through radio speaker only, microphone speaker only, or both speakers at once	Radio, Mic, Both [Both]
<b>SQUELCH LEVEL</b>	Adjusts the present squelch level.	1 to 9 [2]
<b>SQUELCH TAIL</b>	Enables/Disables the squelch tail. When set to OFF the squelch tail is silent.	ON/OFF [ON]
<b>SELCALL ACK</b>	Enables/disables automatic transmission of an acknowledge beep when your SelCall Ident is received.	ON/OFF

Menu	DESCRIPTION	OPTIONS
<b>VERSIONS</b>	Displays model number, serial number, firmware, Bluetooth wireless technology enabled hardware and Bluetooth wireless technology enabled software.	Model, Serial #, Firmware, Bluetooth H/W, Bluetooth S/W
<b>RESET SETTINGS</b>	<p>Cancel: Exits without changes.</p> <p>Reset Radio: Restores the radio to its default settings (i.e Squelch level, beep level, Subtone, etc. but retains user data such as SelCall memories and Zones.</p> <p>Factory Reset: Restores the radio to its 'out-of-the-box' state. Deletes all user data and restores default settings.</p>	

## SCAN SETTINGS

---

1. Press the **MENU** key.
2. Use the **▲** or **▼** keys to select **SCAN SETTINGS** then press **MENU**.
3. Use the **▲** or **▼** keys to select **CB SCAN MEM** then press **MENU**.
4. Use the **▲** or **▼** keys to select from memory 'A', 'B' or 'C' then press **MENU**.
5. The default scan memory allocations are;
  - A – Open Scan
  - B – Priority Scan
  - C – Netscan

## NET-SCAN

---

To use Net-Scan you must also select a CTCSS or DCS sub-tone.

1. Use the **▲** or **▼** keys to select **NETSCAN SUBT** then press **MENU**.
2. Use the **▲** or **▼** keys to scroll through the list of sub-tones then press **MENU** to select.

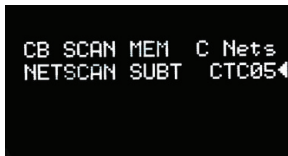

**NOTE:** If you select Netscan as your CB Scan Memory without selecting a sub-tone, you will not be able to scan. Pressing the SCAN key will produce a low 'error' beep.

## SELCALL

---

1. Press the **MENU** key.
2. Use the **▲** or **▼** keys to select **SELCALL** then press **MENU**.
3. Use the **▲** or **▼** keys to select the available options.
  - Select **MAKE SELCALL** to enter and send a SelCall number.
  - Select **Last** to resend or save the last SelCall number you sent.
  - Select **Own** to edit your radio's own SelCall number. Continue scrolling downwards to access a further 20 user programmable SelCall memories.



## MAKING A SELCALL

---

1. To enter and send a SelCall number, select **MAKE SelCall** and press **MENU** [SEL:ENTER].
2. Use the **▲** or **▼** keys to change the digit at the cursor position.
3. Press **MENU** [SEL:NEXT] to step forward to the NEXT digit position or **BACK** to step back to the previous digit position.

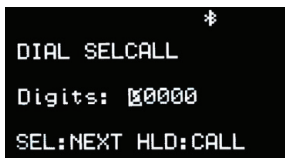

4. Continue until all 5 SelCall digits have been entered. Hold **MENU** [HLD:CALL] to send.



## RESENDING THE LAST SELCALL NUMBER

---

Use the **▲** or **▼** keys to select Last, then HOLD **MENU** [HLD:CALL] to resend the last SelCall number.

```
MAKE SELCALL
▶ Last      #12345
  Own      #10101
  Graham   #10906
SEL: SAVE HLD:CALL
```

```
↩          *
MAKE SELCALL
▶ Last      #12345
  Own      #10101
  Graham   #10906
SELECT SLOT TO SAVE
```

1. Use the **▲** or **▼** keys to scroll down to an empty SelCall memory.
2. Press **MENU** [SEL:EDIT].

```
↩          *
  Graham   #10906
▶          #-----
          #-----
          #-----
SEL:EDIT
```

The 'Edit Contact' screen is displayed and the SelCall number is automatically inserted into the contact.

## EDITING THE CONTACT NAME

---

1. Use the **▲** or **▼** keys to change the character or the cursor position.
2. Press **MENU** [SEL:NEXT] to step forward to the NEXT character position or **BACK** to step back to the previous character position.





Continue until the required name has been entered then hold **MENU** [HLD:SAVE] to save the contact.

## EDITING YOUR RADIO'S OWN SELCALL NUMBER

---

1. Use the **▲** or **▼** keys to select **Own** then press the **MENU** key to edit your radio's own SelCall number.



2. The 'Edit Contact' screen is displayed and **Own** is displayed as the contact name with the cursor on the SelCall number.



3. Use the **▲** or **▼** keys to change the number or the cursor position.
4. Press **MENU** [SEL:NEXT] to step forward to the NEXT digit position or **BACK** to step back to the previous digit position.
5. Continue until the required name has been entered, then hold **MENU** [HLD:SAVE] to save the new number.

## ADDING A NEW CONTACT TO THE SELCALL MEMORY

---

1. Use the **▲** or **▼** keys to scroll to an empty SelCall memory then press **MENU** [SEL:EDIT] to edit.

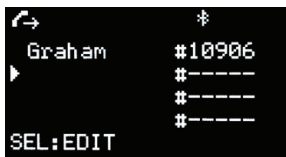

2. Use the **▲** or **▼** keys to change the letter or number at the cursor position.



3. Press **MENU** [SEL:NEXT] to step forward to the NEXT character or digit position or the BACK key to step back to the previous character or digit position.



4. Continue until the required name and SelCall number has been entered then hold **MENU** [HLD:SAVE] to save the new number.

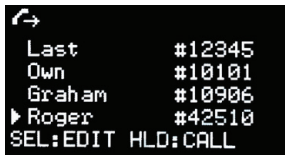

5. The radio returns to the previous screen and displays the new contact entry.

## XRS FEATURES

There are three main feature options available under XRS Features:

- **Location Services**
- **Voice Playback**
- **Active Mute**

### LOCATION SERVICES

---

This feature is used together with the XRS Connect app or with the GPS enabled MC668 microphone and allows the radio to broadcast its GPS location at the end of a normal voice transmission.

With the GPS enabled on the MC668 microphone, you can select to display either @username, direction and distance or @username and #status for incoming transmission. This will be displayed on the microphone screen.

### GPS DATA ACQUISITION

---

When using the built-in GPS receiver of the MC668 microphone to transmit location data the microphone will need to acquire a minimum of 3 satellites.

To acquire satellites, the microphone will require a direct and clear view of the sky. Depending on the mounting location of your microphone and other external factors such as vehicle location and surrounding obstacles, the time it takes to acquire a minimum of 3 satellites can vary from 1 to 5 minutes. For best results, place the microphone close to the windscreen to ensure a clear view of the sky.

The MC668 will acquire satellites if **LOC SOURCE** is set to GPS or App+. If LOC SOURCE is App+ the radio will prioritise the XRS Connect app if connected.

## Navigating to the Location Services feature:

1. Press the **MENU** key.
2. Navigate through the following selections: **XRS FEATURES > LOCATION SERVICES.**

### Location Services Options Table

Menu	Description	Options
LOCATION TX	Enables/disables whether the radio transmits location to other radios (same as share location in XRS Connect app).	ON/OFF
LOC SOURCE (MC668)	This setting allows you to select the source of location data. Select GPS to use MC668 internal GPS only, or App+ to use MC668 internal GPS or XRS Connect app if connected.	GPS/App+
SET ID/STATUS (MC668)	Customise the user ID and status that is transmitted.	User ID/Status
LOC TIMEOUT	This setting allows you to set the location timeout. The radio will not transmit locations with timestamps that are past the timeout specified in this setting.	None - 180 minutes '30 minutes' is the default option.
MIC DISPLAY	Loc= Microphone will display @username direction and distance for incoming transmission. Txt=Mic will display @username and #status for incoming transmission. Off=No display.	Loc/Txt/Off
GPS DISPLAY (MC668)	Displays either a '0' for no GPS signal or the number of GPS satellites acquired.	ON/OFF
SELCALL UID	Turn on to include the radio's SelCall ID in the location data sent.	ON/OFF
TX DATA LIMIT	Allows you to select if data is transmitted once every 15 seconds or approximately every 2 minutes.	ON/OFF
SHOW OWN LOC (MC668)	Displays GPS coordinates as a longitude and latitude plus elevation	Longitude/Latitude/ Elevation

## LOCATION SERVICES

---

### To enable/disable TX location transmit:

1. Press the **MENU** key.
2. Navigate through the following selections **XRS FEATURES > LOCATION SERVICES**.
3. Select **LOCATION TX** and press **MENU** to select **ON** or **OFF**.

### To select GPS location source:

1. Press the **MENU** key.
2. Navigate through the following selections **XRS FEATURES > LOCATION SERVICES**.
3. Select **LOC SOURCE** and press **MENU**.
4. Use the **▲** or **▼** keys to select either **GPS** or **App+** and press **MENU**.

### To set the User ID and Status:

1. Press the **MENU** key.
2. Navigate through the following selections **XRS FEATURES > LOCATION SERVICES > SET ID/STATUS**
3. Use the **▲** or **▼** keys to select either **USER ID** or **STATUS** and press **MENU**
4. Use the **▲** or **▼** keys to change the character at the cursor position
5. Press the **MENU** key to step forward to the **NEXT** character position or the **BACK** key to step back to the previous character position.
6. Continue until the required name has been entered then hold **MENU IHLD:SAVEI** to save the User ID and Status.

### To set location timeout:

1. Press the **MENU** key.
2. Navigate through the following selections **XRS FEATURES > LOCATION SERVICES**
3. Select **LOC TIMEOUT** and press **MENU**.
4. Use the **▲** or **▼** keys to increase or decrease the location timeout then press **MENU**.

### To set mic display:

1. Press the **MENU** key.
2. Navigate through the following selections **XRS FEATURES > LOCATION SERVICES**.
3. Select **MIC DISPLAY** and press **MENU**.
4. Use the **▲** or **▼** keys to select option then press **MENU**.

### GPS Display

When the **GPS DISPLAY** setting is set to **ON**, GPS icon and number will be displayed on the microphone. The number displayed represents the number of satellites acquired from 0 to 9 with a minimum of 3 required to transmit GPS data

### To enable/ disable GPS Display:

1. Press the **MENU** key.
2. Navigate through the following selections **XRS FEATURES > LOCATION SERVICES**.
3. Select **GPS DISPLAY** and press **MENU** to select **ON** or **OFF**.

### To enable/ disable Selcall UID:

1. Press the **MENU** key.
2. Navigate through the following selections **XRS FEATURES > LOCATION SERVICES**.
3. Select **SELCALL UID** and press **MENU** to select **ON** or **OFF**.

### To view GPS Location:

1. Press the **MENU** key.
2. Navigate through the following selections **XRS FEATURES > LOCATION SERVICES**.
3. Select **SHOW OWN LOC** and press **MENU** to display GPS Coordinates.

### TX DATA LIMIT

By default, the **TX DATA LIMIT** is set to **OFF**, the radio will transmit its location data on every PTT, so long as more than 15 seconds have passed since the previous transmission.

When the **TX DATA LIMIT** setting is set to **ON**, this limits the number of location data packets that are transmitted per hour according to **ACMA** requirements, ensuring the allowable limit is not exceeded.

When the radio is ready to transmit its location, regardless of the **TX DATA LIMIT** setting, a small  location marker icon will be shown on the icon bar at the top of the screen and informs the user by way of a warning message, "**Location TX Limit**" and an audible warning beep that the allowable limit has been exceeded.

### To enable/ disable TX Data Limit:

1. Press the **MENU** key.
2. Navigate through the following selections **XRS FEATURES > LOCATION SERVICES**.
3. Select **TX DATA LIMIT** and press **MENU** to select **ON** or **OFF**.

## VOICE PLAYBACK

---

You can enable this feature to allow the radio to record voice transmissions that it receives from other radios, and then playback recorded transmissions. The following are the basic functionalities of the Voice Playback feature:

- Records the first 30 seconds of every transmission received by your radio.
- Stores a total of 12 minutes of recordings (combined time of all recordings).
- When playback begins, the radio begins with the most recent recording. If you scroll back through the list to an older recording, it will play that recording and then work its way through the list to the most recent recording. You can use the up/down keys to scroll through the list of recordings.
- On selecting each recording, the radio's screen displays the following:
  - Name of the recording.
  - Elapsed time since the recording was made (If the radio is switched off, this information will no longer be available when the radio is switched on).
  - The CB channel on which the recording was made.
- Recording also works when the radio is in the Active Mute mode.

### To enable the voice playback feature:

1. Press the **MENU** key.
2. Navigate through the following selections: **XRS FEATURES > VOICE PLAYBACK > ENABLE**.
3. Select **ENABLE** and set to **ON**.



## To playback voice recordings:

When navigating from the main menu:

1. Press the **MENU** key.
2. Navigate through the following selections: **XRS FEATURES > VOICE PLAYBACK > PLAYBACK.**

Alternatively, you can assign the Voice Playback feature to one of the programmable keys (XRS key, or the top programmable key). When the key is pressed, it will begin playback.

To exit the voice playback feature, press the BACK key. Pressing the PRI key or PTT key will also immediately exit the voice playback feature.

## To clear all recordings:

1. Press the **MENU** key.
2. Navigate to the following selections: **XRS FEATURES > VOICE PLAYBACK > CLEAR ALL.**

This selection erases all recordings from the radio.

## Voice Playback Options Table

Menu	Options	
<b>ENABLE</b>	Enables the radio to record voice transmissions that it receives from other radios, and playback recorded transmissions.	ON/OFF
<b>CLEAR ALL</b>	Clears all the existing voice recordings.	-
<b>PLAYBACK</b>	Plays back the recorded voice transmissions, beginning with the most recent recording.	-

## ACTIVE MUTE

---

This feature of the XRS Connect app mutes the XRS Connect radio on phone call, and unmutes the radio at the end of the phone call. You can assign the Active Mute feature to any of the radio's programmable buttons.

## To turn on/off active mute in the XRS Connect app:

1. Open the XRS Connect app.
2. Tap  to display the left navigation menu.
3. Tap the Active Mute slider to turn on/off.  
When the slider turns green, the active mute feature is on.

## To navigate to the Active Mute feature on your radio:

1. Press the **MENU** key.
2. Navigate through the following selections: **XRS FEATURES > ACTIVE MUTE**.

## Active Mute Options Table

Menu	Options	
<b>MUTE TIMEOUT</b>	You can select the Mute Timeout feature to set a time period after which the radio unmutes. Alternatively, you can use the assigned programmable key, or volume up/down keys to exit the mute mode.	None - 180 minutes; '30 minutes' is the default option.
<b>REDUCE VOLUME</b>	Reduces the volume of the radio. By default, the volume level is set to Mute.	Mute, 75%, 50%, or 25% reduction in current volume; 'Mute' is the default option.

# INSTALLATION

## GENERAL

Your XRS Connect radio is supplied with either a slim, slide on mounting cradle or a U-shaped cradle depending on the model.

If the radio contains a built-in speaker, for maximum sound projection from the internal speaker we recommend the cradle be mounted above the radio to minimise any obstruction of the speaker. Alternatively, if it is necessary to mount the unit in a less audible location, an extension speaker can be used. The

extension speaker plugs into the extension speaker socket on the radio's rear panel.

If the radio does not contain a built-in speaker, the cradle can be screwed or bolted to any convenient location in your vehicle's cabin (under or above the dash, on the centre console, under or beside the seat, etc) using the mounting slots provided in the cradle.

When planning your installation, avoid locations that are close to heaters or air conditioners.

The mounting cradle design supports a wide range of flexible mounting options. The radio can be mounted above or below the cradle and the cradle can be orientated with the arms extending either forwards or backwards to adjust the position of the front panel with reference to the mounting point.

## MOUNTING THE CRADLE

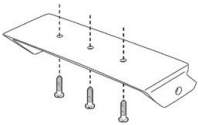
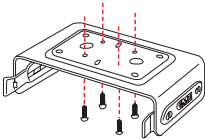
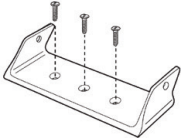
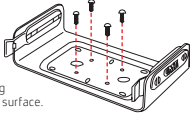
<b>XRS-330C</b>	<b>XRS-370C / XRS-390C</b>
<p data-bbox="89 690 178 713"><b>Option 1</b></p> 	
<p data-bbox="89 963 178 987"><b>Option 2</b></p> 	 <p data-bbox="428 1141 592 1176">Screw mounting cradle to a firm surface.</p>

## FITTING THE CONTROLLER MICROPHONE

Plug the 8 pin plug into the socket on the front of the main unit or alternatively you can use the adapter and extension cable supplied with the radio (XRS-330C and XRS-370C only). If the main unit is not easily accessible this adapter will allow you to bring the microphone socket to a more convenient position. Attach the microphone clip to a convenient location near your driving position using screws or a 3M VHB adhesive patch (3MAP). Slide the bollard on the back of the microphone into the clip to secure it.



## DC POWER CONNECTION

The radio is designed for 13.8 volt DC, negative earth installations only (i.e. Where the negative terminal of the battery is connected to the chassis or frame of the vehicle).

There are two recommended methods of installation.

## RADIO REMAINS ON WHEN THE IGNITION SWITCH IS OFF

Connect the radio's negative (black) lead to the vehicle's chassis, or if preferred, directly to the battery's negative terminal. The radio's positive (red) lead should be connected via the 2 amp fuse to the battery's positive terminal.

Alternatively, the positive lead could be connected into the fuse box at a point that has +13.8 volts continuously available (on the battery side of the ignition switch) via the 2 amp fuse.

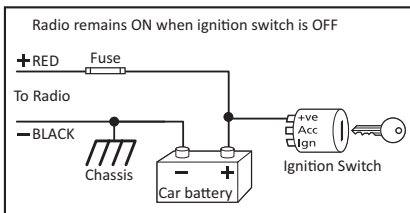

If you are connecting directly to the battery, please review the 'Auto Power-Down' feature for information on options to turn the radio off after a user-selectable time.

## RADIO TURNS ON AND OFF WITH THE IGNITION SWITCH

---

Connect the radio's negative (black) lead to the vehicle's chassis, or if preferred, directly to the battery's negative terminal. The radio's positive (red) lead should connect to an accessory point in the vehicle's fuse box via the 2 amp fuse. This point should supply +13.8 volts only when the ignition switch is turned ON or in the ACCESSORY position via the 2 amp fuse.

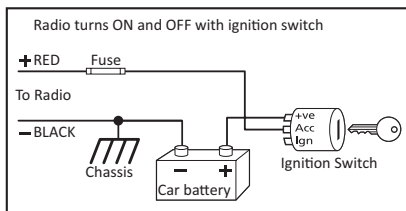

## HIGH VOLTAGE DETECTION

---

The radio has a built-in, high voltage detection system to warn you if an over voltage situation occurs. If the power supply voltage exceeds 18 volts DC, the display will flash 'High DC' for 1 second and will sound a warning beep. If you are transmitting, 'High DC' will be displayed and the output power will be reduced to 1 watt.

If the 'High DC' warning appears you should switch your radio OFF and disconnect it from the power source, before locating the cause of the trouble.

**NOTE:** The High DC warning will remain on the display even if the normal voltage level is restored. You will need to switch the radio OFF then ON again to reset it and clear the 'High DC' warning.

**IMPORTANT:** The power source should never exceed 30 volts.

## MOUNTING THE RADIO

---

### XRS-330C

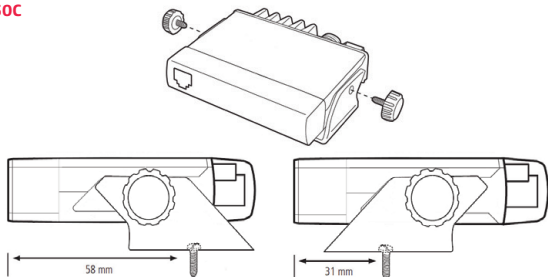

---

### XRS-370C

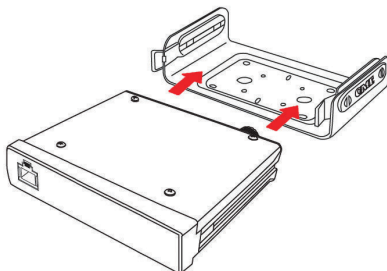

Slide the radio fully into cradle \_\_\_\_\_  
until it clicks into place.

### XRS-390C

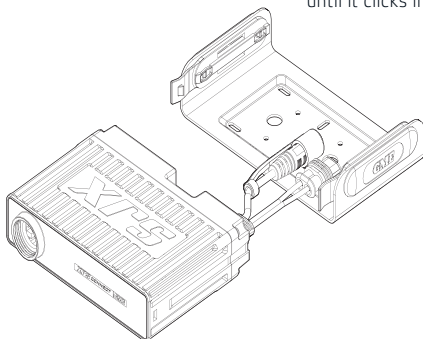

## **ANTENNA CONNECTION**

---

It is essential to select a good quality, high efficiency, 477 MHz antenna. A poor quality antenna or one not designed for the specific frequency band you are using will give very poor performance. GME has a wide range of suitable 477 MHz UHF CB antennas to suit most installations and applications. We recommend contacting your local GME retailer for advice.

Connect the antenna cable to the rear antenna socket using an FME coaxial connector.

## **NOISE SUPPRESSION**

---

The inherent design of FM transceivers results in a high level of resistance to ignition and electrical interference. However in some installations it may be necessary to take additional steps to help reduce or eliminate noise interference.

During installation, try to route the DC battery leads, the antenna lead or any accessory wires away from the engine compartment, ignition or alternator wiring. If the noise continues, it may be necessary to fit a suppression kit in which case we recommend you consult an auto electrician for advice specific to your installation.

Higher frequency electrical interference cause by electric motors can be suppressed directly at the motor terminals.

## WIRING

### XRS-330C and XRS-370C

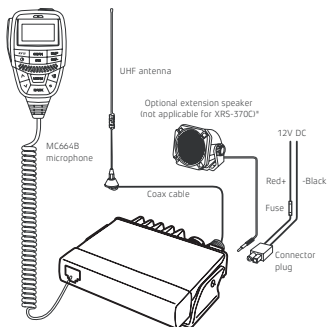

### XRS-390C

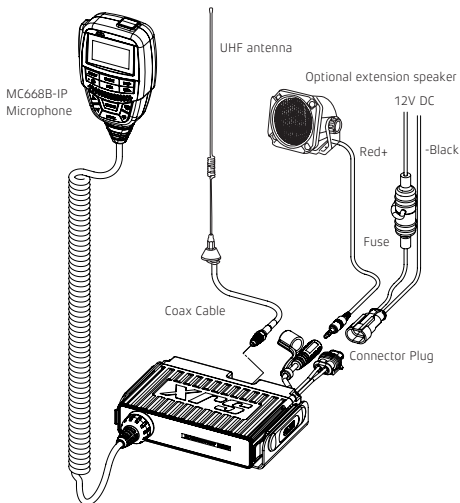



## FREQUENCY AND SUBTONE TABLES

---

The table that follows details the CTCSS tone frequencies of the XRS Connect radio.

CTCSS Tone Frequencies							
No.	Frequency	No.	Frequency	No.	Frequency	No.	Frequency
1	67.0	14	107.2	27	167.9	40	159.8
2	71.9	15	110.9	28	173.8	41	165.5
3	74.4	16	114.8	29	179.9	42	171.3
4	77.0	17	118.8	30	186.2	43	177.3
5	79.7	18	123.0	31	192.8	44	183.5
6	82.5	19	127.3	32	203.5	45	189.9
7	85.4	20	131.8	33	210.7	46	196.6
8	88.5	21	136.5	34	218.1	47	199.5
9	91.5	22	141.3	35	225.7	48	206.5
10	94.8	23	146.2	36	233.6	49	229.1
11	97.4	24	151.4	37	241.8	50	254.1
12	100.0	25	156.7	38	250.3	–	–
13	103.5	26	162.2	39	69.4	–	–

The table that follows details the DCS tones of the XRS Connect radio.

<b>DCS Tone Chart</b>											
DCS	Code	DCS	Code	DCS	Code	DCS	Code	DCS	Code	DCS	Code
1	023	19	116	37	225	55	325	73	452	91	627
2	025	20	122	38	226	56	331	74	454	92	631
3	026	21	125	39	243	57	332	75	455	93	632
4	031	22	131	40	244	58	343	76	462	94	654
5	032	23	132	41	245	59	346	77	464	95	662
6	036	24	134	42	246	60	351	78	465	96	664
7	043	25	143	43	251	61	356	79	466	97	703
8	047	26	145	44	252	62	364	80	503	98	712
9	051	27	152	45	255	63	365	81	506	99	723
10	053	28	155	46	261	64	371	82	516	100	731
11	054	29	156	47	263	65	411	83	523	101	732
12	065	30	162	48	265	66	412	84	526	102	734
13	071	31	165	49	266	67	413	85	532	103	743
14	072	32	172	50	271	68	423	86	546	104	754
15	073	33	174	51	274	69	431	87	565	-	-
16	074	34	205	52	306	70	432	88	606	-	-
17	114	35	212	53	311	71	445	89	612	-	-
18	115	36	223	54	315	72	446	90	624	-	-

The table that follows details the UHF CB operating frequencies of the XRS Connect radio.

## UHF CB Operating Frequencies

CH	Frequency (MHz)	CH	Frequency (MHz)	CH	Frequency (MHz)	
1	476.425	28	477.100	55	476.7875	
2	476.450	29	477.125	56	476.8125	
3	476.475	30	477.150	57	476.8375	
4	476.500	31	477.175	58	476.8625	
5	476.525	32	477.200	59	476.8875	Emergency use only
6	476.550	33	477.225	60	476.9125	Telemetry / Selcall use only. Voice transmission is inhibited as required by AS/ NZS 4365.2011
7	476.575	34	477.250	61	476.9375	
8	476.600	35	477.275	62	476.9625	
9	476.625	36	477.300	63	476.9875	
10	476.650	37	477.325	64	477.0125	Guard band channel. Transmission is inhibited as required by AS/ NZS 4365.2011
11	476.675	38	477.350	65	477.0375	
12	476.700	39	477.375	66	477.0625	
13	476.725	40	477.400	67	477.0875	
14	476.750	41	476.4375	68	477.1125	Repeater input channels (Duplex)
15	476.775	42	476.4625	69	477.1375	
16	476.800	43	476.4875	70	477.1625	Repeater output channels (Duplex)
17	476.825	44	476.5125	71	477.1875	
18	476.850	45	476.5375	72	477.2125	Officially designated call channel
19	476.875	46	476.5625	73	477.2375	
20	476.900	47	476.5875	74	477.2625	Road channel
21	476.925	48	476.6125	75	477.2875	
22	476.950	49	476.6375	76	477.3125	Caravan and motor home
23	476.975	50	476.6625	77	477.3375	
24	477.000	51	476.6875	78	477.3625	4WD / Off road
25	477.025	52	476.7125	79	477.3875	
26	477.050	53	476.7375	80	477.4125	
27	477.075	54	476.7625			

# SPECIFICATIONS

## ELECTRICAL

### General

<b>Compliant Specification:</b>	Meets AS/NZS 4365 for radio communications equipment in the UHF citizen and personal radio service
<b>Frequency Range TX:</b>	476.425-477.4125 MHz
<b>Number of Channels:</b>	80
<b>Channel Spacing:</b>	12.5 kHz
<b>Operation Mode:</b>	Simplex or half Duplex with repeater talk-around
<b>Scanning Speed:</b>	20 ms per channel (50 channels per second)
<b>Antenna Impedance:</b>	50 Ohms nominal
<b>Nominal Battery Voltage:</b>	12 volts DC
<b>Operating Voltage Range:</b>	10 - 16 volts DC
<b>Battery Polarity:</b>	Negative Earth
<b>Standard Test Voltage:</b>	13.8 volts DC
<b>Over Voltage Protection:</b>	30 volts DC maximum. At 18 volts DC the channel display flashes 'Hi DC' for 5 seconds on receive. The RF power is reduced and TX flashes on transmit
<b>Reverse Voltage Protection:</b>	Diode Crowbar
<b>Over-current Protection:</b>	In-line 2 amp fuse
<b>Operating Temperature:</b>	-10° C to +60°C

## Transmitter

<b>RF Output:</b>	5 watts
<b>Spurious Emission:</b>	< - 70 dBc
<b>Frequency Error:</b>	< $\pm$ 1.5 kHz
<b>Modulation:</b>	FM
<b>Maximum Deviation:</b>	< $\pm$ 2.5 kHz at + 20 Db AF limiting
<b>Transmit Frequency Response:</b>	+6 dB per octave 300 Hz to 3 kHz + 1 . 3 dB
<b>Demodulated Audio Signal to Noise:</b>	>45 dB unweighted
<b>Current Consumption:</b>	1.7 amps with 50 Ohms termination

## Receiver

<b>Intermediate Frequencies:</b>	38.85 MHz, 450 kHz
<b>Sensitivity:</b>	-122 dBm for 12 dB SINAD unweighted
<b>Selectivity:</b>	-6 dB at $\pm$ 3.5 kHz, -60 dB at $\pm$ 12.5 kHz
<b>Intermodulation Immunity:</b>	-72 dB
<b>Blocking Immunity:</b>	-98 dB
<b>Spurious Response Immunity:</b>	70 dB
<b>Audio Output Power:</b>	3 watts average into 4 Ohms
<b>Audio Signal to Noise:</b>	>45 dB unweighted
<b>Receive Frequency Response:</b>	-6 dB/Octave de-emphasis 300 Hz to 3 kHz +1 -3 dB
<b>Current Consumption:</b>	<175 mA muted, 750 mA full volume
<b>Conducted Spurious Emission:</b>	<70 dBm

## MECHANICAL SPECIFICATIONS AND CONNECTIONS

---

### XRS-330C

<b>Dimensions:</b>	22 (H) x 99.5 (L) x 86 (D) mm
<b>Weight:</b>	137 grams
<b>12 Volt Power Supply:</b>	Two core cable with bulkhead connector in rear panel
<b>Antenna:</b>	FME panel socket
<b>External Speaker:</b>	3.5 mm mono jack
<b>Front Microphone Port:</b>	8 Pin RJ45 Connection

### XRS-370C

<b>Dimensions:</b>	29 (H) x 128 (L) x 117 (D) mm
<b>Weight:</b>	450 grams
<b>12 Volt Power Supply:</b>	Two core cable with bulkhead connector in rear panel
<b>Antenna:</b>	50 239 panel socket
<b>External Speaker:</b>	3.5 mm mono jack
<b>Front Microphone Port:</b>	8 Pin RJ45 Connection

### XRS-390C

<b>Dimensions:</b>	29 (H) x 128 (L) x 92 (D) mm
<b>Weight:</b>	310 Grams
<b>12 Volt Power Supply:</b>	Two core cable with IP67 2 pin connection
<b>Antenna:</b>	FME panel socket
<b>External Speaker:</b>	3.5 mm mono jack
<b>Front Microphone Port:</b>	8 Pin RJ45 IP67 Connection

Specifications are subject to change without notice or obligation





[gme.net.au](http://gme.net.au)  
GME Pty Ltd

17 Gibbon Road, Winston Hills NSW 2153, Australia  
Part Number: 311147 Drawing Number: 52210-1